

Irregularity of microhardness and microstructure of low-carbon steel rolled in a two-stand rolling-leveling mill

© 2023

*Vladimir P. Ivanov*¹, Doctor of Sciences (Engineering), Professor
Stanislav V. Pilipenko^{*2}, PhD (Engineering), Associate Professor
*Oleg P. Shtempel*³, PhD (Engineering), Associate Professor
*Tatyana V. Vigerina*⁴, PhD (Engineering), Associate Professor

Euphrosyne Polotskaya State University of Polotsk, Novopolotsk (Republic of Belarus)

*E-mail: s.pilipenko@psu.by,
44-08@mail.ru

¹ORCID: <https://orcid.org/0000-0002-4621-7155>²ORCID: <https://orcid.org/0000-0002-1110-2016>³ORCID: <https://orcid.org/0000-0001-7247-0798>⁴ORCID: <https://orcid.org/0000-0002-8862-5456>

Received 07.04.2023

Accepted 16.06.2023

Abstract: The relevance of the study is proved by two factors. One of them is the necessity to study the nature of the change in the microstructure of the cross-section of extra-thin tinplate made of TS 435 steel (analogue of 08ps steel) skin-passed in a new DSR-1250 mill of the Miory Metal Rolling Plant. The second factor is the need to develop an effective method for obtaining accurate geometry characteristics of an oblique cut of tinplate 0.19 mm or less thick. The purpose of the work is to determine the changes in microhardness and microstructure over the thickness of tinplate samples and identify the existence of a layer microstructure necessary for this type of flat-rolled products. The study was carried out on the selected samples of tinplate of TS 435 steel 0.19 mm thick. This tinplate was rolled from an annealed strip, 0.224 mm thick. The total magnitude of reduction in the mill was 15 %, and the reduction in the skin-pass stand was at least 3 %. The authors carried out measurements of microhardness at different points over the thickness of the selected tinplate samples. The microhardness values over the strip thickness were averaged using 6th degree polynomial interpolation. To study the grain dimension, a number of microstructure images were taken in various areas over the sheet thickness with $\times 500$ magnification. The microstructure studies showed a pronounced strain microstructure with grains elongated in the direction of rolling. At the very boundary of metal contacting the rolls, the grains received the greatest deformation. The highest values of microhardness were identified in two zones adjacent to both strip surfaces and in the central layers along the strip thickness. The change in the microhardness values along the sheet thickness has a wave-like character with three pronounced zones of increase in hardness and two zones of a decrease in its values. The zones with the lowest microhardness values are located between the zones with the maximum values.

Keywords: tinplate; low-carbon steel TS 435; microhardness irregularity; microstructure irregularity; strip section; oblique cut; grain dimension ratio; rolling-leveling mill.

Acknowledgements: The authors express their sincere gratitude to the management of OOO Metal-Rolling Company (Miory, the Republic of Belarus) for the provision of samples for the research and participation in the discussion of the results.

For citation: Ivanov V.P., Pilipenko S.V., Shtempel O.P., Vigerina T.V. Irregularity of microhardness and microstructure of low-carbon steel rolled in a two-stand rolling-leveling mill. *Frontier Materials & Technologies*, 2023, no. 2. DOI: 10.18323/2782-4039-2023-2-64-9.

INTRODUCTION

Cold-rolled sheets are one of the most commonly used types of rolled products. Many scientific papers cover the study of the development of the theory and technology of cold sheet rolling. The necessary final properties of such sheet-rolled products as tinplate are provided by skin-pass rolling, the technology of which largely determines the quality of tinplate [1–3]. In most cases, tinplate itself is a blank for cold stamping [4]. It is very important that during such processing, no destruction of the sheet integrity occur, and no shear lines form on its surface [5; 6]. Skin pass ensures good formability, good sheet flatness, and the required surface roughness [5]. The latter is especially important when applying coatings to the sheet surface (tinning, etc.). Tensile diagrams of tempered sheets does not show a yield plateau or its length is significantly reduced [6–8]. This allows increasing the stamping process accuracy and prevents distortion of stamped parts [6; 9; 10].

When tempering mild-carbon steel sheets with a percentage reduction of up to 1.2 %, the yield strength of the material decreases. This is explained by the processes of the nucleation of new dislocations. At percentage reductions of more than 1.2 %, the yield strength begins to increase [5]. As a rule, when tempering mild-carbon steel sheets, the percentage reduction is in the range from 0.5 to 3 %. Skin pass is performed after cold-rolled sheets are annealed (as a rule, in a shielding atmosphere) [11–13].

In 2020, a tinplate production line was put into operation at the Miory Metal Rolling Plant [14]. According to the technical characteristics, the installed equipment allows rolling sheet metal with a minimum thickness of 0.15 mm.

Two rolling mills are installed within the production line: RCM-1250 – a six-roll reversing mill for cold thin-sheet rolling, and DSR-1250 – a continuous rolling-leveling mill consisting of one reduction stand (quarto) and one skin-pass stand (quarto).

The plant receives rolls of pickled annealed sheet of 2 mm in thickness. The technological process of cold

rolling of sheets at this plant consists of the following main operations (Fig. 1). After the preparation process, the coils (1) are rolled in several passes to the desired thickness (2) on a RCM-1250 reversing mill (3). Next, the rolls (4) after electrolytic cleaning (5) are fed for annealing. Annealing is carried out in bell-type furnaces with a shielding atmosphere (6). Annealed coils are transferred for rolling in a DSR-1250 two-stand rolling-leveling mill (7 and 8).

After rolling the strips in the DSR-1250 mill, the coils are transferred for tinning, cutting, reeling, and packaging (9, 10).

At the DSR-1250 mill, the process of reduction of the sheet annealed in a shielding atmosphere and the process of its tempering are carried out sequentially. It is obvious that rolling is carried out with tension. The study of special aspects of such process, including changes in the microhardness and microstructure of the metal along the tin strip thickness is of interest.

In the process of skin pass, with an increase in the degree of deformation, the tensile strength and hardness of the metal increase, and the yield strength, up to the limit of the deformation degree determined for each metal, first decreases and then increases. Thus, it is convenient to judge the degree of deformation of a given metal during skin pass by the change in its microhardness, since this value continuously increases.

The aim of the research is to study the microstructure, and the nature of the change in microhardness along the thickness of a sheet of tempered tinplate strips made of TS 435 steel (manufactured in accordance with the EN 10202:2001 requirements).

METHODS

The study was carried out on a tinplate strip made of TS 435 steel (a 08ps grade analogue according to the GOST 1050 standard) 0.19 mm thick. This tinplate is rolled from an annealed strip 0.224 mm thick in a DSR-1250 mill. The total value of the percentage reduction in the mill was 15 %, the value of the percentage reduction in the skin-pass mill was 3 %.

To study microhardness and microstructure, the following technique was developed.

Samples were cut out from areas in the middle of the width of the rolled tinplate strip along and across the rolling direction.

To ensure the possibility of performing multiple measurements of microhardness over the thickness of a tin strip (0.19 mm), the authors used the technology of grinding the surface at an angle of 3° . This gives the possibility of performing microhardness measurements at a large number of points over the thickness of the strip on an oblique ground cut. The sample preparation technology for oblique grinding of a tin strip is shown in Fig. 2.

As is seen from Fig. 2 a sample prepared for studying, an oblique cut in the form of a tinplate strip was glued onto a base strip (Fig. 2 a) ground at an angle of 3° to the horizontal line. The curing of the adhesive on specimens prepared in this way must take place under load. In this case, the specimen strips were pressed with a rubber-sealed clamp (the sample strip is pressed against the base by a surface with an inclination of 3°). It is possible to use a press, (with the same sealing parts and a container

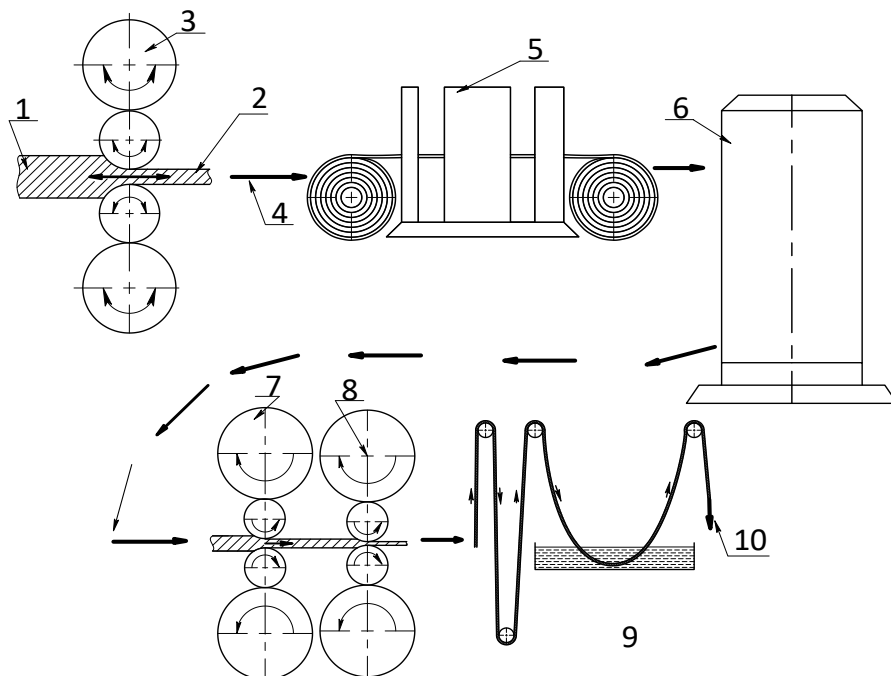

Fig. 1. Tinplate production at Miory Metal Rolling Plant:

- 1 – coils of etched annealed sheet 2 mm thick; 2 – a strip leaving the RCM-1250 mill; 3 – RCM-1250 reversing mill;
4 – movement of coils along the technological line of the workshop; 5 – electrolytic cleaning plant; 6 – bell-type furnaces;
7 – cogging stand of the DSR-1250 mill; 8 – pinch-pass stand of the DSR-1250 mill; 9 – tinning stack;
10 – cutting, coiling, packing, and sales

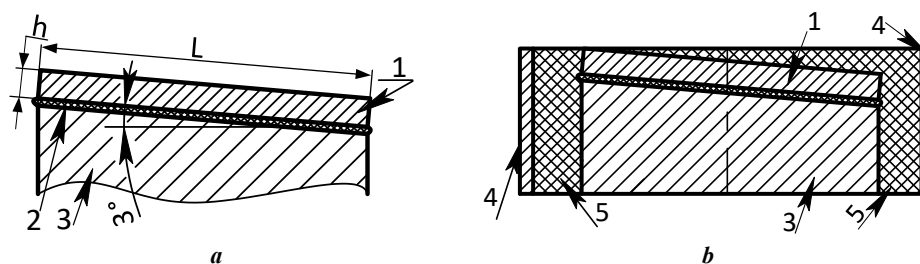

Fig. 2. The technology of preparing a specimen for an oblique cut to study tinplate microstructure:

a – sticking tinplate strips on the base metal; **b** – pouring the specimen with epoxy resin.

1 – test tinplate strip with the corresponding length of the platform to measure microhardness along the tin strip thickness; 2 – fast-setting glue layer; 3 – base strip; 4 – cylindrical container; 5 – epoxy resin; h – tinplate strip thickness

providing the desired position of the sample strip, the base, and the surface pressing the strip against it). After the adhesive has hardened (Fig. 2 b), the sample is placed in a container and poured with epoxy resin. After the resin hardens, the unnecessary part of the tin strip under study is ground off.

Fig. 3 shows the container with the samples after grinding. It is evident that on the samples prepared by the above-described method (Fig. 2), in the process of flat grinding of the container with the samples, an oblique cut angle of 3° is formed spontaneously.

The samples were prepared on a Presi Mecapol P262 polishing station. The microstructure was studied using a Nikon Epiphot 200 microscope, with a magnification up to 1000 times. Vickers hardness was determined on a Buehler Model No 1105D microhardness tester. The etchant is Rzheshotarsky's solution (5 % solution of nitric acid in alcohol).

Surface microhardness measurements were carried out using the Vickers method with a small load on a Buehler Model No 1105D microhardness tester. The force was 0.9807 N, which corresponds to the HV 0.1 hardness scale. The load application time is 10 s. A diamond tip was used with the working part in the form of a tetrahedral pyramid with a rhombic base.

During the study of rolled steel samples, the following operations were carried out:

- multiple microhardness measurements on the tin strip surfaces followed by deriving the average values for certain samples;

- multiple microhardness measurements for the end sections with microhardness measurements at three points: 40 μm from the edge of the strip surface of each end section, and in the middle of the section. Average values were derived (separately for each edge and middle of a particular end section);

- multiple microhardness measurements on the oblique cuts with a step of 50–100 μm along the oblique cut. Up to 25 measurements were made at each coordinate. Average values were derived according to the technique described in [15; 16].

The hardness measuring uncertainty was leveled by measuring a number of hardness reference gages (the spread of hardness values is within the range of $\pm 12.5\%$) [17].

The grain size, in the middle regions of the strip cross section was calculated by counting the intersections of grain boundaries [18; 19]. Based on the sheet thickness, a segment with a length of 0.08 mm was chosen to count the intersections along the X and Y axes. To count the number of grain intersections along the diagonal line (against the X and Y axes), a segment length of 0.113 mm was chosen. The segments were located on each image at random. One should note that the X -axis always coincided with the sheet thickness.

The grain size, in near-surface regions, was determined by counting the intersections of grain boundaries [20]. The counting was carried out along the Y axis on a number of segments 0.09 mm in length. The segments were located on each image at random.

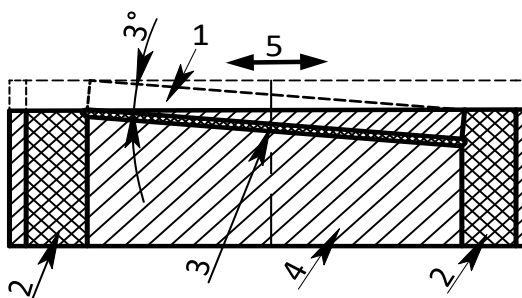

Fig. 3. A container with tinplate specimens after flat grinding machine:

1 – ground part of a specimen; 2 – epoxy resin; 3 – fast-setting glue layer; 4 – metal base with a glued specimen; 5 – movement direction of a grinding tool

RESULTS

Fig. 4 demonstrates the metal microstructure of the strip fed for skin pass to the DSR-1250 mill and pre-annealed in a bell-type furnace with a shielding atmosphere (Fig. 1, position 6).

Fig. 4 shows that the microstructure of samples from annealed TS 435 steel is a generally homogeneous ferritic structure, with pronounced equilibrium grains. Finely dispersed inclusions, probably of a carbide nature, are distributed over the body of the ferrite grains relatively evenly. The microhardness in the near-surface zone of the strip is $79.71 \text{ HV} \pm 7\%$, in the middle regions – $78.89 \text{ HV} \pm 5.5\%$.

As one can see from the analysis of the measurement results (Fig. 5 and 6), three zones of the highest hardness values are observed in the samples:

- on both surfaces of the strip;
- in the central layers of the strip thickness.

At a depth of 0.04 to 0.05 mm from the strip surface on the end cut, and of 0.01 to 0.015 mm on oblique cuts, zones of the lowest hardness values are observed. Thus, the averaged microhardness values (obtained by interpolation with a 6-th degree polynomial) show a wavelike change in the hardness values, over the sheet depth with three pronounced zones of increasing hardness, and two zones of decreasing hardness values. In other words, different layers over the sheet depth received different degrees of deformation.

Fig. 7 shows photographs of the microstructures of the cross sections of the investigated tinplate strips. The microstructure study on a thin section of the tin strip thickness located along the rolling direction (Fig. 7 a)

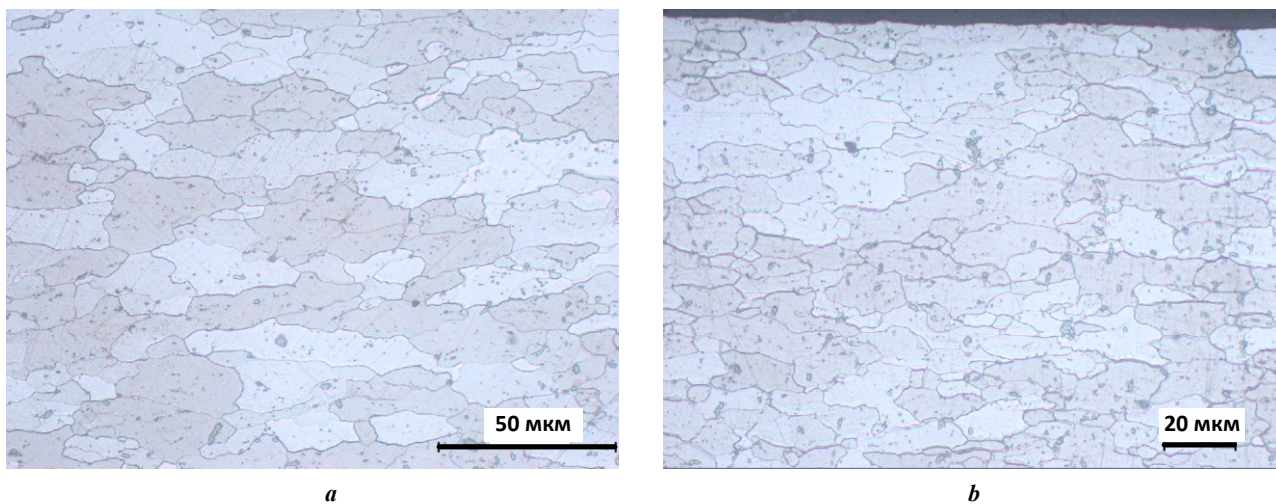

Fig. 4. Metal microstructure of an annealed TS 435 steel strip 0.224 mm thick, which is fed to the DSR-1250 mill for skin pass ($\times 500$):
a – central part of the strip cross section; **b** – surface part of the strip cross section

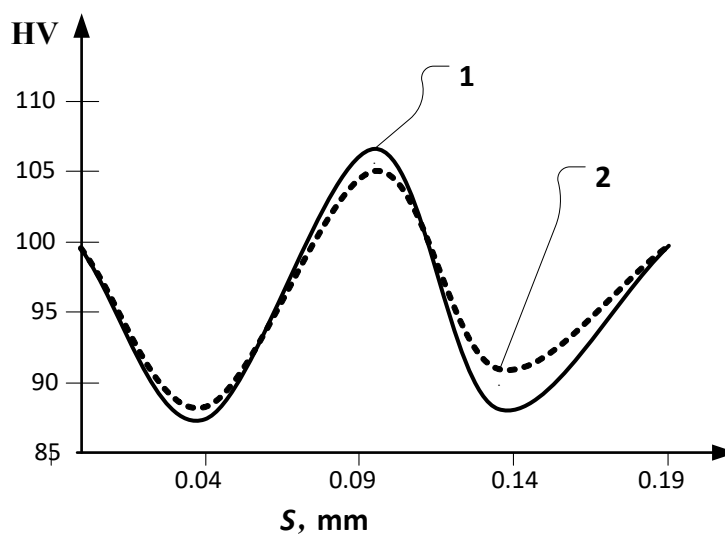

Fig. 5. Microhardness distribution along the thickness of the TS 435 steel sheet 0.19 mm thick subjected to skin pass in the DSR-1250 mill, according to the results of measurements from the sheet end face:
S – depth (measurement coordinate) along the sheet thickness; *HV* – microhardness on the oblique cut surface;
 1 – cross cut measurements; 2 – along cut measurements

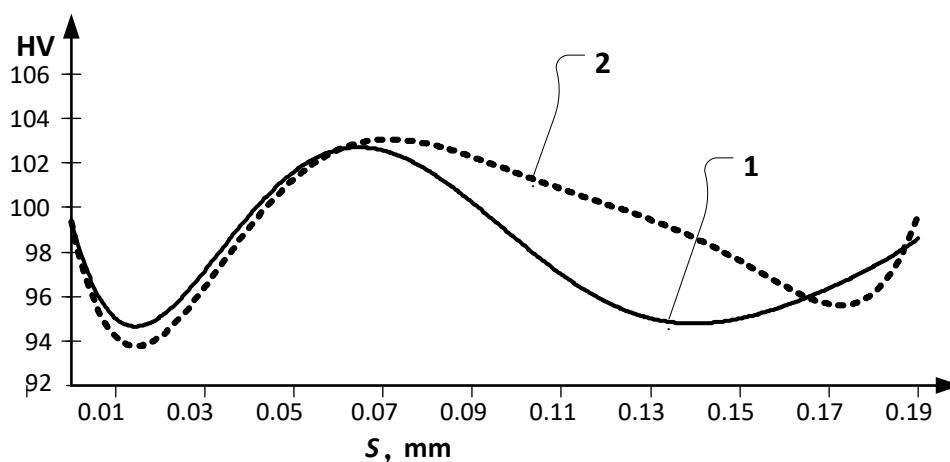

Fig. 6. Microhardness distribution along the thickness of the TS 435 steel sheet 0.19 mm thick subjected to skin pass in the DSR-1250 mill, according to the results of measurements on the oblique cut surface: HV – microhardness on the oblique cut surface; S – depth (measurement coordinate) along the sheet thickness; 1 – cross cut measurements; 2 – along cut measurements

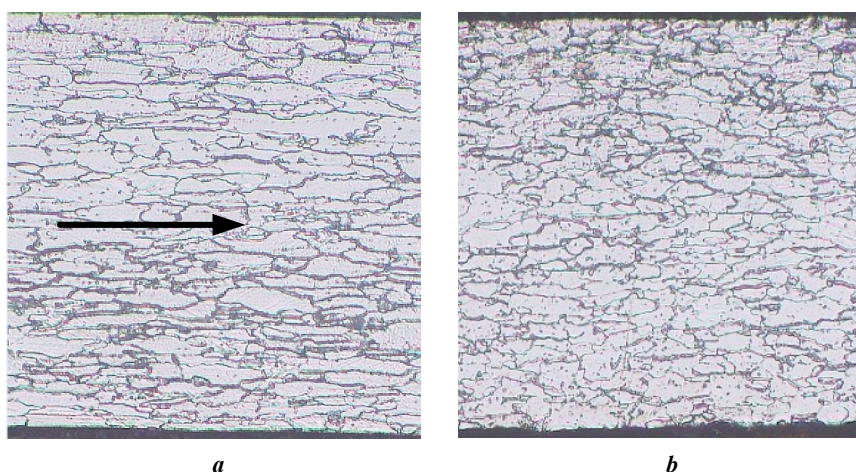

Fig. 7. Microstructure of the TS 435 steel tinplate sheet 0.19 mm thick: a – microstructure in the strip thickness section ($\times 200$) along the rolling line (an arrow – the rolling direction); b – microstructure in the strip thickness section ($\times 200$) across the rolling line (the rolling direction – toward us)

showed the presence of a clearly pronounced banded (fibrous, elongated) microstructure along the rolling direction. The grains are elongated in the direction of longitudinal deformation (along the rolling line).

On the section, where the tin strip thickness is located in the plane across the rolling line (Fig. 7 b), the width of the grains is less than their length on the section made along the rolling direction.

To study the grain size, a number of microstructure photographs were taken in the regions bordering the tin strip surface (Fig. 8 a and 9 a) and in the middle regions of the strip (Fig. 8 b and 9 b). The photographs were taken with a magnification of 500 times. From the photographs, one can judge the change in the microstructure along the cross section of the strip.

The calculation gave the following results:

– in the sheet thickness area bordering the surface, in the section along the rolling line, along the X axis –

305 grains (1.6 mm), along the Y axis – 119 grains (2.4 mm), along the diagonal line – 322 grains (2.263 mm);

– in the sheet thickness middle area, in the section along the rolling line, along the X axis – 567 grains (3.28 mm), along the Y axis – 98 grains (2.56 mm), along the diagonal line – 357 grains (2.828 mm);

– in the sheet thickness border area, in the section across the rolling line, along the X axis – 273 grains (1.6 mm), along the Z axis – 181 grains (2.4 mm), along the diagonal line – 296 grains (2.263 mm);

– in the strip thickness middle region, in the section across the rolling line, along the X axis – 289 grains (2.08 mm), along the Z axis – 152 grains (2.32 mm), along the diagonal line – 256 grains (2.263 mm).

The calculation data were processed according to the standard procedure [16; 18]. Tables 1 and 2 provide data on the average grain size in the directions described above.

In addition to grain sizes, data on the average ratio of the grain length along the Z axis to the length along the X axis both across the rolling line (grain width coefficient), and along the rolling line (grain length coefficient) were obtained.

When determining the grain size in the area of contact between the metal and the rolls, 103 grains were counted across the rolling line (1.44 mm) and 56 grains (1.8 mm) along the rolling line. The results of grain size calculations along the rolling line (grain length) and across it (grain width) are summarized in Table 3.

DISCUSSION

It is determined that the microstructure of the studied samples is a ferrite with different degrees of plastic deformation over the sheet thickness.

There are obvious differences in the microstructure on sections made along and across the rolling line (Fig. 7–9), since this factor was mainly influenced by the schemes of plastic deformation during preliminary cold rolling in the first stand and skin pass in the second stand of a DSR-1250 continuous 2-roll rolling-leveling mill.

Tables 1 and 2, show that the grain length coefficient is always greater than the grain width coefficient, both in the border and in the central regions over the strip width. This is quite natural for sheet rolling [15; 20]. One can conclude that the broadening of the grains in the central regions is somewhat less than the broadening of the grains in the regions bordering the strip surface (width coefficient 2.311 versus 2.208). This can be caused by the action of friction forces acting along the rolling line on the contact surface of the rolls and metal.

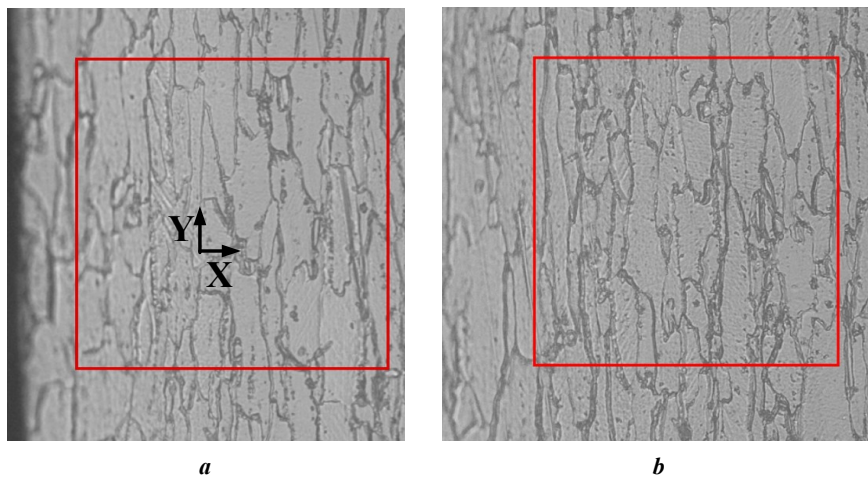

Fig. 8. Tinplate microstructure in the thickness sections of the TS 435 steel sheet 0.19 mm thick in the plane along the rolling direction line ($\times 500$):
a – sheet end face area adjacent to the surface; **b** – sheet end face middle area (a square 0.08×0.08 mm).
 X -axis is oriented along the sheet thickness, Y -axis – along the rolling axis

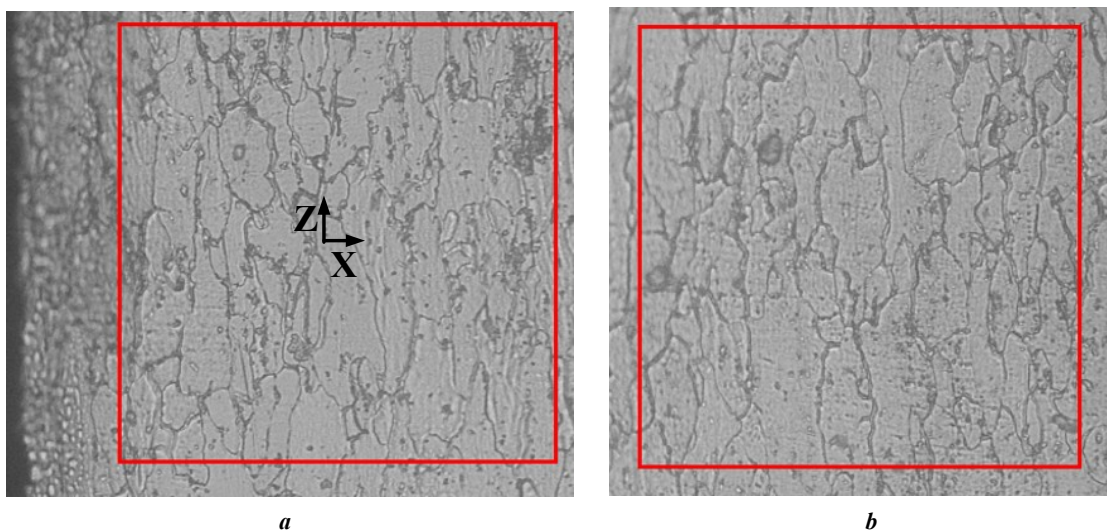

Fig. 9. Microstructure of the TS 435 steel tinplate sheet 0.19 mm thick in the plane across the rolling direction line ($\times 500$):
a – sheet end face area adjacent to the surface; **b** – sheet end face middle area (a square 0.08×0.08 mm).
 X -axis is oriented along the sheet thickness, Z -axis – across the rolling axis (along the sheet width)

Table 1. The average grain size in the section across the rolling line

Measurement point	A cut across the rolling line		
	Measurement axis	Average grain size, mm	The average ratio of grain length along the Z axis (over the strip width) to the length along the X axis (over the strip thickness)
Edge of sheet thickness	X	0.00594±12.5 %	2.311
	Z	0.01374±15.0 %	
	along the diagonal	0,00767 ^{+12.0%} _{-7.5%}	
Middle of sheet thickness	X	0.00728±12.5 %	2.208
	Z	0.01608±16.0 %	
	along the diagonal	0.00908±10.5 %	

Table 2. The average grain size in the section along the rolling line

Measurement point	A cut along the rolling line		
	Measurement axis	Average grain size, mm	The average ratio of grain length along the Y axis (along the rolling line) to the length along the X axis (over the strip thickness)
Edge of sheet thickness	X	0.00534±14.5 %	4.017
	Y	0.02145±12.0 %	
	along the diagonal	0.00714±12.5 %	
Middle of sheet thickness	X	0.00589±14.5 %	4.716
	Y	0.02779±12.5 %	
	along the diagonal	0.00808±12.0 %	

Table 3. The average grain size in the metal-to-roll contact area

Measurement point	Measurement axis	Average grain size, mm	The average ratio of grain length along the Y axis to the length along the X axis
In the contact area of the metal and a roll	A cut – across the rolling line		2.299
	X	0.01398±11.5 %	
	A cut – along the rolling line		
	Y	0.03214±12 %	

Considering the grain length factor, one can conclude that the grains in the border areas received less elongation than the grains in the middle regions of the sheet thickness (grain length factor 4.017 versus 4.716).

The smallest grain size in all cases, was identified when counting the number of grains along the diagonal lines, and along the X axis. From a visual analysis of the microstructure photographs of the near-border areas, it can be noticed that the grains at the very border of the contact of the metal, with the rolls receive the greatest deformation.

In the middle areas, where deformation occurs under a significant action of tensile stresses, grain fragments, and even single destroyed grains are encountered, which is natural and acceptable.

Tables 1 and 2 show, that the average ratio of the grain length to its width is 1.561 in the extreme region of the tin strip end and 1.729 in its middle parts.

As one can see from Table 3, the ratio of grain length to width is 2.299. Thus, in two areas, the grains received a large elongation – in the area of direct contact of the metal with the roll (sheet surface), and in the middle regions relative to the sheet thickness. It is these areas where the increased values of microhardness are observed.

Therefore, during the study of the changes in the microstructure and microhardness of ultra-thin tinplate made of TS 435 steel rolled in a DSR-1250 mill, the expected existence of a layered structure of strips, which is typical for tempered sheet material, was confirmed. According to the work [1; 2; 6; 10], the formation of such a layered microstructure prevents the Chernov–Luders lines from coming to the surface of the stamped sheet, and helps to improve sheet formability. As practice shows, when tinning strips with a similar structure, the adhesion of the tinned layer to the surface improves.

The nature of the change in microhardness over the thickness of the strips is confirmed by the corresponding nature of the change in the microstructure. It was identified that the near-surface layers, as well as the middle ones, receive a greater degree of deformation than the metal layers between them. Probably, such behaviour of mechanical characteristics over the sheet thickness is associated with the presence of a significant degree of metal tension between the stands of the DSR-1250 two-stand mill. It is known that during the rolling of the strips on such mill, sometimes even their tightening was observed, which is definitely caused by the influence of the strip tension.

CONCLUSIONS

During skin-pass carried out on a DSR-1250 continuous rolling-leveling mill produced by SMS group, the necessary multilayer structure occurs in pre-annealed cold-rolled thin sheets made of TS 435 steel, in which different layers have individual microstructure combinations (grain elongation degree, grain size, etc.) and mechanical properties.

In the areas of metal adjacent to the tin surfaces, the layers were subjected to the deforming effect of the rolls to a greater extent than the subsurface layers. As a result, surface zones were formed, characterised by higher hardness and strength. In the surface zones, a greater degree of grain elongation is observed than in the subsurface ones.

In the subsurface layers, lower hardness values are observed. The grains of these layers received lower strain va-

lues. The highest hardness values are noted in the central regions of the sheet cross section. Separate destroyed grains are observed here. It is possible that the higher hardness of the central layers is associated with a significant degree of strip tension between the stands of the DSR-1250 two-stand mill. These findings require further, broader research.

REFERENCES

1. Mazur V.L., Nogovitsyn O.V. *Theory and Technology of Sheet Rolling: Numerical Analysis and Applications*. London, CRS Press Publ., 2019. 477 p.
2. Mazur V.L. Preventing surface defects in the uncoiling of thin steel sheet. *Steel in Translation*, 2015, no. 45, pp. 959–966. DOI: [10.3103/S0967091215120062](https://doi.org/10.3103/S0967091215120062).
3. Wang D.-C., Liu H.-M., Liu J. Research and Development Trend of Shape Control for Cold Rolling Strip. *Chinese Journal of Mechanical Engineering*, 2017, no. 30, pp. 1248–1261. DOI: [10.1007/s10033-017-0163-8](https://doi.org/10.1007/s10033-017-0163-8).
4. Kozhevnikov A.V. The Development and Application of Methodologies for the Design of Technological Modes of Cold Rolling. *IOP Conference Series: Materials Science and Engineering*, 2020, vol. 718, article number 012007. DOI: [10.1088/1757-899X/718/1/012007](https://doi.org/10.1088/1757-899X/718/1/012007).
5. Pimenov A.F., Soskovets O.N., Trayno A.I., Mazur V.L., Chernov P.P., Dobronravov A.I. *Kholodnaya prokataka i otdelka zhesti* [Cold rolling and finishing of tinplate]. Moscow, Metallurgiya Publ., 1990. 206 p.
6. Timofeeva M.A., Garber E.A. *Protsess dressirovki kholodnokatanykh stalnykh polos (teoriya, tekhnologiya, oborudovanie, tendentsii ikh razvitiya i sovershenstvovaniya)* [The process of training cold-rolled steel strips (theory, technology, equipment, trends in their development and improvement)]. Cherepovets, ChGU Publ., 2017. 155 p.
7. Ogarkov N.N., Zvyagina E.Y., Ismagilov R.R. Theoretical analysis of formation of automobile sheet roughness during temper rolling in shot-blasted rolls. *Steel in Translation*, 2019, vol. 49, no. 8, pp. 499–503. DOI: [10.3103/S0967091219080138](https://doi.org/10.3103/S0967091219080138).
8. Cui H., Chen H., Lu L., He Z. Determinant parameters of surface morphology to corrosion behaviour of cold-rolled auto sheet steel. *Journal of Materials Science*, 2021, no. 56, pp. 8297–8308. DOI: [10.1007/s10853-021-05812-6](https://doi.org/10.1007/s10853-021-05812-6).
9. Poddar V.S., Rathod M.J. Evaluation of mechanical properties of cold roll bonded mild steel and aluminum. *Materials Today: Proceedings*, 2021, vol. 43-5, pp. 3014–3022. DOI: [10.1016/j.matpr.2021.01.363](https://doi.org/10.1016/j.matpr.2021.01.363).
10. Li T., Yan S., Liu X. Enhancement austenite content in medium-Mn steel by introducing cold-rolled deformation and inhibiting subsequent recrystallization. *Materials Letters*, 2021, vol. 301, article number 130249. DOI: [10.1016/j.matlet.2021.130249](https://doi.org/10.1016/j.matlet.2021.130249).
11. Mazur V.L., Nogovitsyn O.V. *Theory and Technology of Sheet Rolling. Numerical Analysis and Applications*. New York, CRC Press Publ., 2018. 500 p.
12. Zakarlyuka S.V., Yurchenko Yu.I., Goncharov V.E., Budakva S.A. Non-flatness parameters variation in case of elastic stretching of strips Non-flatness parameters variation in case of elastic stretching of strips.

- Modelirovanie i razvitie protsessov OMD*, 2018, no. 24, pp. 3–12. EDN: [UQLSOA](#).
13. Zaytsev A.I., Rodionova I.G., Koldaev A.V., Arutyunyan N.A., Aleksandrova N.M. Effect of composition and processing parameters on microstructure and mechanical properties of cold-rolled and galvanized roll products from IF-steels. *Metallurg*, 2020, no. 6, pp. 41–47. EDN: [URLJOH](#).
 14. Dyakonov V.A., Pilipenko S.V., Shtempel O.P. Influence of deformation on the mechanical properties of tinned tin. *Vestnik Polotskogo gosudarstvennogo universiteta. Seriya B. Promyshlennost. Prikladnye nauki*, 2022, no. 10, pp. 18–24. EDN: [YFNRXI](#).
 15. Li L., Matsumoto R., Utsunomiya H. Experimental Study of Roll Flattening in Cold Rolling Process. *ISIJ International*, 2018, vol. 58, no. 4, pp. 714–720. DOI: [10.2355/isijinternational.ISIJINT-2017-623](#).
 16. Bogush R.P., Adamovskiy E.R., Denisenok S.F. Processing and analysis of images of microstructure metals for determining the grain point. *Doklady Belorusskogo gosudarstvennogo universiteta informatiki i radioelektroniki*, 2021, vol. 19, no. 4, pp. 70–79. DOI: [10.35596/1729-7648-2012-19-4-70-79](#).
 17. Anisovich A.G. Problems of application of standards in evaluation of microstructure of metals and alloys. *Izvestiya Natsionalnoy akademii nauk Belarusi. Seriya Fiziko-tekhnicheskikh nauk*, 2021, vol. 66, no. 1, pp. 12–19. DOI: [10.29235/1561-8358-2021-66-1-12-19](#).
 18. Anisovich A.G., Rummyantseva I.N., Bislyuk L.V. Determination of steel grain grade by computer methods. *Lite i metallurgiya*, 2010, no. 3S, pp. 100–104. EDN: [UJNMCT](#).
 19. Anisovich A.G., Andrushevich A.A. *Mikrostruktury chernykh i tsvetnykh metallov* [Microstructures of ferrous and non-ferrous metals]. Minsk, Belaruskaya navuka Publ., 2015. 131 p.
 20. Li S., Wang Z., Guo Y. A novel analytical model for prediction of rolling force in hot strip rolling based on tangent velocity field and MY criterion. *Journal of Manufacturing Processes*, 2019, vol. 47, pp. 202–210. DOI: [10.1016/j.jmapro.2019.09.037](#).